

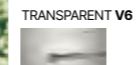

INCLUDED

- PLATINUM SUPERBRIGHT PT
- SILVER MATT PM
- BLACK MATT NM



PROFESSIONAL SPATULA



Exclusive gift with your shower screen.

AT EXTRA COST

- GOLD OB
- NICKEL NI



RAL SEE PAGE 187

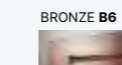

RIBBED GLASS Y6



MIRROR ES6

FROSTED GLASS / DECO
SEE PAGES 194 - 197

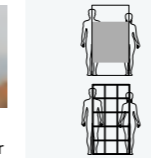

Moderate Watertightness



Knob P4



Interior cleaning without obstacles.



Glass flush hinge.

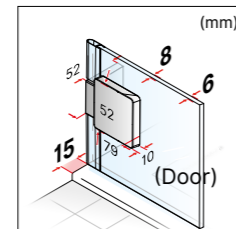

For other lines and installation options, please consult

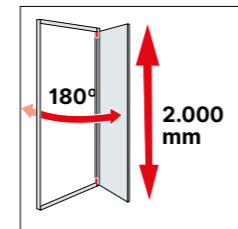

Special height: from 1.801 to 2.500 mm.



Access: website / configurator.

- Pivot door 180° inwards and outwards.
- Fixed panel width will change in relation with product total width.
- Angle magnetic closing.
- 5 mm adaptation margin for out-of-true walls.
- Includes 45° crossbar profile from a width of 995 mm

D4 Pure

Pivot twin door 180° + 2 In-line panels, for shower with angle access

Standard heights: 2.000 mm

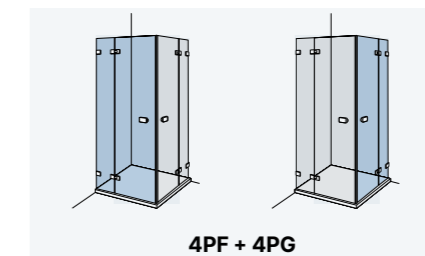

SHOWER WITH ANGLE ACCESS.

Angle Width	Transparent Glass
4PF	
500 ↔ 900	
901 ↔ 1.200	
1.201 ↔ 1.400	
4PG	+
500 ↔ 900	
901 ↔ 1.200	
1.201 ↔ 1.400	

For product widths up to 950 mm, the fixed panel maintains a standard width of 180 mm. For widths over 950 mm, the door will measure 745 mm, and the fixed panel will occupy the remaining width.

For the price calculation of the corner entry version, must be **SUMMED** the amounts for the left and right side of the shower doors in the required dimensions.

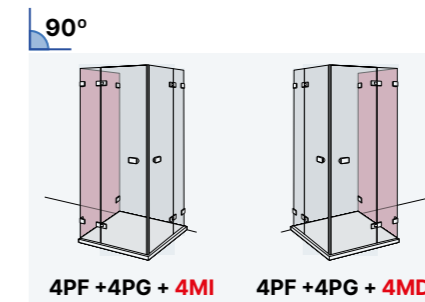

90° SIDE PANEL FOR COMBINATION WITH ANGLE ACCESS.

Lateral Width	Transparent Glass
200 ↔ 500	
501 ↔ 1.000	
1.001 ↔ 1.200	

The set price is obtained by adding the angle with the side in the desired measurements.

SURCHARGES FOR OPTIONS

Measurements

- Height different from standard up to 2.200 mm
- Height different from standard from 2.201 to 2.500 mm.

Profiles

- Gold (OB) / Nickel (NI)
- Optional colours RAL

Glass

- Velum Frosted
- Smoke / Bronze
- Ribbed Glass
- Deco
- Mirror on Panel
- Cut-outs (please send sketch; consultation required)

Surcharge Application: Additional costs are applied to the base price with the standardized height. If the shower screen has a special height, the height-related fee is added first, and then all other applicable charges are calculated based on the updated amount.